



CSC Series - 2000 Watt

Central Emergency Power System Lighting Inverter (2000W)



PROJECT: _____
 FIXTURE TYPE: _____
 LOCATION: _____
 CONTACT/PHONE: _____

CEPS lighting inverters are a powerful, reliable, and cost effective way to meet emergency lighting and life safety requirements for a wide range of applications.

PRODUCT FEATURES

Turn any fixture into an emergency fixture, with full light output, for 90 minutes.

- Operates fluorescents, dimmable fluorescent ballasts, CFL, LED, halogen & incandescent loads.
- Self-resetting overload protection and fused output
- Automatic Output Voltage Tracking maintains output voltage at full load \pm 3%
- 120VAC or 277VAC Pure Sine Wave Output 2000W load for 90 minutes
- Sealed Lead Calcium batteries provide long life and are maintenance free
- 3/6 Warranty (3 year replacement warranty on electronics, 6 year pro-rata warranty on batteries)
- Automatic low voltage battery disconnect, deep discharge protection, over-temperature shut down, and reverse polarity protection
- Distortion (THD): Less than \pm 5%
- EMI in compliance with FCC Class A Regulation
- Test switch to simulate utility power loss.
- Normal Operation Efficiency: 98% at Full Load
- Thermostat Controlled Silent Cooling Fan
- Load Power Factor: 0.9 leading to 0.9 lagging
- 1.5 seconds transfer time to protect against momentary ON/OFF voltage surges caused by power line hitting wet pavement or other power lines during a storm
- Operating Temperature: 40°F to 100°F
- Frequency Regulation: \pm 5%
- Less than 3% Input Power Consumption when batteries are fully charged.
- Automatic low voltage battery disconnect, deep discharge protection, over-temperature shut down, and reverse polarity protection.
- Equipped with one 20A Output Breaker standard. Up to 5 additional breakers may be added for a total of 6.



DIMENSIONS

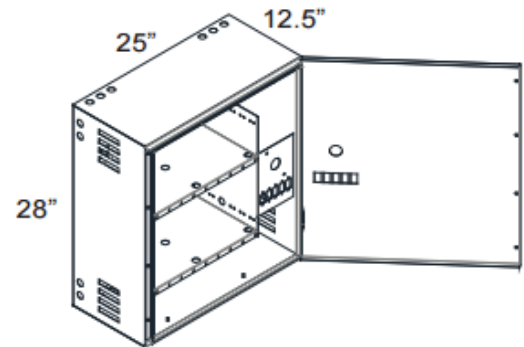

LED COMPATIBLE



UL924 LISTED



WARRANTY

ORDERING INFORMATION

Model	Watts*	Input/Output Voltage	Output Breakers	Options
CSC	2000	120 (120VAC)	1CB (standard)	ATS Self Test
		277 (277VAC)	#CB**	STATUS Dry Contacts

*Capacity for 90 minutes. Derate by 15% to reduce inrush related issues.

**One 20A output breaker comes standard. Up to 5 additional may be added for total of 6.

Ordering Example: CSC-2000-120-4CB

CSC Series - 2000 Watt

Central Emergency Power System Lighting Inverter (2000W)



PROJECT: _____
FIXTURE TYPE: _____
LOCATION: _____
CONTACT/PHONE: _____

APPLICATION

The CSC Series is typically used in one of three applications:

- In a standalone application, a single CSC powers all emergency lighting for a building or space.
- In a multi-inverter application, multiple CSC power a larger emergency lighting load. Typically, the CSC will be mounted in smaller electrical rooms or closets close to the lights powered by the inverter. Since large inverter or generator systems are typically broken into multiple circuits, using several CSC provides greater reliability (no single point of failure), while making troubleshooting and service easier. Unlike large multiple kW systems, the CSC does not require a factory service tech for service. This solution is economically competitive with standalone large systems in both initial and maintenance costs.
- In a generator backup application, a CSC will provide power to emergency lighting during the period (up to several minutes) after utility power is interrupted, but before the generator starts up. If the generator fails to start, the CSC will carry the entire emergency load for up to 90 minutes.

OPERATION

The CSC Transfer Control will feed Utility Power through RL 1 (see below). This will supply all emergency loads connected to the CSC. Supervisory LED's will indicate that utility feed, inverter, and charger are all energized and operating properly. Test switch is easily accessible without opening cover and may be pressed to switch CSC to emergency mode. The CSC Transfer Control will feed pure sine wave Inverter Power through RL2 (see below). This will supply all emergency loads connected to the CSC for up to 90 minutes. Optional CEC emergency lighting controls in each room allow emergency fixtures to be controlled from regular wall switches, occupancy sensors, or dimmers during normal operation, but will automatically illuminate emergency fixtures at full brightness during emergency operation. Up to 2000W of Fluorescent, Incandescent, LED, halogen, and CFL Loads. Upon power failure the CSC will transfer from utility power to inverter power through relays RL1 and RL2 (see below. These relays are electronically interlocked with a time delay, which prevents arcing when transferring between two out of phase power sources. This safety feature protects the CSC loads as well as expensive equipment on both sides of the inverter.

SINGLE LINE DRAWING

Note: Mule suggests to derate inverter by 15% with all lighting loads to greatly reduce inrush related problems.

