



Installation And Operation Instructions

For SPS Series Mini-Inverter Power Systems

Models: SPS-55/125, SPS-110/125, SPS-110/250, SPS-220/250
Surface (-S), Recessed (-R) and Ceiling T-Grid (-T) Mounted Versions



READ AND FOLLOW ALL SAFETY INSTRUCTIONS

IMPORTANT SAFEGUARDS

When using electrical equipment, basic safety precautions should always be followed, including the following:

READ AND FOLLOW ALL SAFETY INSTRUCTIONS:

- *Do not use outdoors.*
- *Do not let power supply cords touch hot surfaces.*
- *Do not mount near gas or electric heaters.*
- *Use caution when servicing batteries. Battery acid can cause burns to skin and eyes. If acid is spilled on skin or in eyes, flush acid with fresh water and contact a physician immediately.*
- *Equipment should be mounted securely in locations and at heights where it will not be readily subjected to tampering by unauthorized personnel.*
- *The use of accessory equipment not recommended by the MANUFACTURER may cause an unsafe condition.*
- *The AC voltage rating of this equipment is specified on the product label. Do not connect equipment to any other voltage.*
- *Do not use this equipment for other than its intended purpose.*
- *Servicing of this equipment should be performed by qualified service personnel.*

SAVE THESE IMPORTANT SAFETY INSTRUCTIONS

The installation and use of this product must comply with all national, federal, state, municipal, or local codes that apply.

Please read this manual thoroughly before operating the SPS Inverter System.

Table of Contents

<i>Description</i>	<i>Page</i>
Section 100	
System Installation Instructions	
101. Unit Specifications	4
102. Receiving, Moving and Storing Systems and Batteries	5
102.1 Shipping Damage	5
102.2 Temporary Storage of Units and Batteries	5
103. Installation Requirements	5
103.1 Operating Environment.....	5
103.2 High Altitude Operation.....	5
104. Cabinet Mounting	6
104.1 Tools Required.....	6
104.2 Mounting Hardware.....	6
104.3 Knockout Locations.....	6
104.4 Cabinet Mounting - Surface (-S) Models.....	6
104.5 Cabinet Mounting - Recessed (-R) Models.....	7
104.6 Cabinet Mounting - Ceiling T-Grid (-T) Models).....	7
105. AC Connections	8
105.1 AC Wiring Preparations	8
105.2 AC Input and AC Output Connections	8
Wiring Diagram 1 - 120VAC Connections.....	9
Wiring Diagram 2 - 277VAC Connections.....	10
106. Battery Information.....	11
106.1 Tools.....	11
106.2 Battery installation and Connections.....	11
Wiring Diagram 1 - 24V Surface and Recessed Mount Models.....	12
Wiring Diagram 2 - 24V Ceiling T-Grid Mount Models	12
Wiring Diagram 3 - 48V Surface Mount Models.....	12
106.3 Battery Connection Voltage Check	13
107. Final Installation Checklist	13
108. System Start-Up Procedure	13
109. System Test	13

Section 200

Maintenance

200.1 Safe Shut Down Procedure	14
200.2 Routine System Maintenance.....	14
200.3 Manual Routine Inverter Tests	14
200.4 Routine Battery Inspection and Maintenance.....	15
200.5 Battery Replacement Procedure.....	15
200.6 Battery Disposal.....	15

Section 100 System Installation Instructions

101. Specifications

Input

- Input voltage: Universal 120 or 277VAC.
- Input frequency: 60HZ \pm 2%
- Operating temperature : 20°C to 30°C (68°F to 86°F)
- Input surge protection: Meets UL 924

Output

- Output voltage: Universal 120 or 277VAC, 60HZ. Other voltages available upon request
- Output regulation: (static) \pm 5% based on a 0% - 100% resistive load
- Minimum loading: none required
- Output distortion: Less than 3% THD linear load
- Load power factor: .44 lead to .44 lag
- Output frequency: \pm 0.3 Hz during emergency
- Time to transfer to inverter after a utility power failure: <1 second

Battery

- Battery type: Maintenance free sealed lead calcium
- Battery charger: Fully automatic dual-mode with temperature compensation
- Recharge time: Meets UL requirements (96 Hours)
- Battery protection: Automatic low-battery voltage disconnect and reverse polarity protection.
- Battery switch: Also used as battery isolator
- Standard battery: Sealed lead-calcium: 10-year life
- Battery voltage: 24 or 48 (system dependent - See Table 1 below)
- Runtimes: 90 minutes standard.
- Operating temperature: 20°C to 30°C (68°F to 86°F)
- Relative humidity: 95% non-condensing

Note: Battery performance rated at 25°C (77°F)

Table 1

System Model Number	Type	Input/Output Volts	Capacity For 1 1/2 Hours In Watts	Battery Voltage (VDC)	Cabinet Dimensions			System Weight*	
					Length	Height	Depth	(Lbs.)	(Kg.)
SPS-55/125-S	Surface	120/277	55	24	16 5/8" (42.2cm)	11 5/8" (29.5cm)	4 1/4" (10.8cm)	32	14
SPS-110/125-S	Surface	120/277	110	24	16 5/8" (42.2cm)	11 5/8" (29.5cm)	4 1/4" (10.8cm)	38	17
SPS-110/250-S	Surface	120/277	110	48	16 5/8" (42.2cm)	11 5/8" (29.5cm)	4 1/4" (10.8cm)	47	21
SPS-220/250-S	Surface	120/277	220	48	16 5/8" (42.2cm)	11 5/8" (29.5cm)	4 1/4" (10.8cm)	60	27
SPS-55/125-R	Recessed	120/277	55	24	18 1/8" (46.0cm)	13 1/8" (33.3cm)	4 1/4" (10.8cm)	32	14
SPS-110/125-R	Recessed	120/277	110	24	18 1/8" (46.0cm)	13 1/8" (33.3cm)	4 1/4" (10.8cm)	38	17
SPS-55/125-T	Ceiling Grid	120/277	55	24	23 7/8" (60.6cm)	6 1/4" (15.9cm)	8.0" (20.3cm)	32	14
SPS-110/125-T	Ceiling Grid	120/277	110	24	23 7/8" (60.6cm)	6 1/4" (15.9cm)	8.0" (20.3cm)	38	17

* System weights shown include installed batteries

Table 2

System Model Number	On-Line System Efficiency (Full Load)	Number Of Batteries	Battery Voltage (VDC)	Battery Current (Amps)	AC Input Current		Thermal Output In BTUs	
					120VAC (Max.)	277VAC (Max.)	On-Line	Emergency
					SPS-55/125	98%		
SPS-110/125	98%	2	24	5.7	1.2	0.52	9	95
SPS-110/250	98%	4	48	3.3	2.4	1.1	18	163
SPS-220/250	98%	4	48	5.6	2.4	1.1	18	167

102. Receiving, Moving and Storing Systems and Batteries

102.1 Shipping Damage

SPS inverter system batteries are shipped installed within the unit housing with the exception of the SPS 220/250 model in which the batteries are shipped separately.

Carefully inspect all cartons upon receipt for evidence of shipping damage.

Notify carrier immediately of leaking or damaged cartons for possible concealed damage.

102.2 Temporary Storage of Units and Batteries

For temporary storage of **SPS** inverter systems and batteries prior to installation, select a clean, cool, dry location with normal ventilation for human habitation and level floors.

Storage Temperature:

Store all batteries at 0° to +40° C (32° to +104° F). Batteries will have a longer shelf life if stored at 15° C (60° F). The **SPS** electronics and battery cabinets may be stored at -20° to +60° C (-4° to +140° F).

IMPORTANT:

Lengthy storage of batteries will cause irreversible damage to the cells.

*Failure to connect **SPS** inverter system batteries to an energized charging circuit within 90 days from the date of shipment will void the battery warranty.*

DANGER: Explosive - Can Cause Blindness Or Other Severe Injuries

Every type of battery can produce hydrogen gas, even sealed, maintenance-free batteries. The gas is vented through the vent caps and into the air. Do not allow smoking, sparks, or flames in battery storage location because hydrogen is concentrated under the vent cap of each cell of the battery. Hydrogen is highly explosive, and is hard to detect because it is colorless, odorless, and lighter than air.

103. Installation Requirements

103.1 Operating Environment

Install the **SPS** inverter system in a clean, cool, dry place with normal ventilation for human habitation and in such a location to hamper vandalism but allow easy access for testing and maintenance.

Operating Temperature:

***SPS** inverter Systems are UL Listed for 20° to 30° C (+ 68° to +86° F) operation.*

Battery performance and service life is maximized if the operating temperature is maintained at 25° C (77° F).

Temperature Effect On Battery Performance:

Batteries will be less efficient at temperatures below 20° C (68° F), and high temperatures will reduce battery life. Typically, at 35° C (95° F), battery life will be half of what it would be at normal temperature of 25° C (77° F). At 45° C (113° F), battery life will be one-fourth of normal.

Ventilation:

*The air around the unit must be clean, dust-free, and free of corrosive chemicals or other contaminants. Do not place the **SPS** inverter system or batteries in a sealed room or container.*

CAUTION: Never Install Batteries in A Sealed Room Or Enclosure

103.2 High Altitude Operation:

The maximum operating temperature drops 1° Celsius per 300 meters (2° F per 1000 feet) above sea level. Maximum elevation is 3000 meters (10,000 feet).

104. Cabinet Mounting

104.1 Tools Required

The following tools are required to install the system:

Socket Set, Phillips Screwdriver, Diagonal Wire Cutters, Long Nose Pliers, Electrical Tape, Digital Volt-Ohm Meter, Safety Glasses with Side Shields, Small Punch (knockout removal), Hammer, Electric Drill, Wood or Masonry Bits, Level.

104.2 Mounting Hardware

Mounting hardware is not provided. Care should be taken when selecting mounting hardware to assure that it is the proper type for the application and sized to safely support the systems full weight when installed assuring safe and secure attachment of system to wall surface. For ease of installation, the factory recommends that the head size of mounting screws or bolts be small enough to pass through the keyhole knockouts provided for mounting. This will allow the unit to be hung on partially installed mounting hardware and facilitate easy cabinet removal if ever necessary.

104.3 Knockout Locations

All models provide knockouts on the top and left-hand side of the unit.

Additional entry points, if required can be added using a metal punch. Do not drill into the cabinet as metal filings can cause short circuits and damage the equipment.

NOTE: Consider unit knockout locations prior to mounting unit. Allow room for easy routing of conduit to entry point.

104.4 Surface Mount (-S) Models:

- 1) Remove cover and any packing material inside unit housing that may have been used for shipping purposes.
- 2) For ease of installation, and to prevent possible damage to the equipment, the inverter/charger assembly may be temporarily removed prior to knockout removal and attachment to mounting surface. This is accomplished by removing (4) 8-32 hex nuts on the inverter/charger mounting plate. If shipped factory installed, batteries may also be temporarily removed to facilitate ease of installation.
- 3) Remove the appropriate knockouts, 7/8" diameter, on the top and/or left side of the unit housing to facilitate conduit attachment. Also remove keyhole knockouts in the upper corners on the back of the housing on models **SPS-55/125-S** and **SPS-110/125-S** models. Due to the additional battery weight, **SPS-110/250-S** and **SPS-220/250-S** models are supplied with mounting keyhole knockouts located at all four corners on the back of the unit housing. Remove all four keyhole knockouts on these models.
- 4) Secure housing to mounting surface through all keyhole knockouts provided using mounting hardware (not supplied) sized appropriately to support the unit weight.
- 5) Re-install inverter/charger assembly if removed in step 2.



104.5 Recessed Mount (-R) Models:

- 1) Remove cover and any packing material inside unit housing that may have been used for shipping purposes.
- 2) For ease of installation, and to prevent possible damage to the equipment, the inverter/charger assembly may be temporarily removed prior to knockout removal and attachment to mounting surface. This is accomplished by removing (4) 8-32 hex nuts on the inverter/charger mounting plate. If shipped factory installed, batteries may also be temporarily removed to facilitate ease of installation.
- 3) Remove the appropriate knockouts, 7/8" diameter, on the top and/or left side of the unit housing to facilitate conduit attachment. Also remove the appropriate round knockouts, 5/16" diameter, which are located on all sides of unit housing. Specific knockout requirements are dictated by mounting orientation of unit (vertical or horizontal) and location of wall studs and /or other support members.
- 4) Secure housing to support members through round knockouts using mounting hardware (not supplied) sized appropriately to support the unit weight.
IMPORTANT: Unit should be so positioned that the cabinet extends between 3/8" and 3/4" beyond the finished wall surface after installation.
- 5) Prior to final attachment of unit cover, the LED indicator panel assembly position must be adjusted to sit flush against inside surface of cover after attachment. This is accomplished using the (2) 8-32 hex nuts on the indicator assembly.
- 6) Re-install inverter/charger assembly if removed in step 2.



104.6 Ceiling T-Grid Mount (-T) Models:

- 1) Remove cover and any packing material inside unit housing that may have been used for shipping purposes.
- 2) For ease of installation, and to prevent possible damage to the equipment, the inverter/charger assembly may be temporarily removed prior to knockout removal and attachment to mounting surface. This is accomplished by removing (4) 8-32 hex nuts on the inverter/charger mounting plate. If shipped factory installed, batteries may also be temporarily removed to facilitate ease of installation.
- 3) Remove the appropriate knockout(s), 7/8" diameter, located on either side of unit housing to facilitate conduit attachment.
IMPORTANT: Take care to remove only the knockouts required for utility connection. Removal of knockouts if unused and left open will void the plenum rating of the unit.
- 4) Mount the unit securely in place between T-Grid members.
NOTICE: Safety chain or cable, rated 50lb minimum working load, 250lb minimum breaking strength is required to hang the unit in a T-Grid system. Failure to correctly install unit will cause an unsafe condition!
- 5) Re-install inverter/charger assembly if removed in step 2.



105. AC Connections

CAUTION:

- A) All **SPS** inverter system units contain hazardous AC and DC voltages. Because of these voltages, a qualified electrician must install the **SPS** inverter system, AC line service, and batteries. The electrician must install the AC line service according to local, state and NEC codes and must be familiar with batteries and battery installation.
- B) Before installing, maintaining, or servicing the unit, always remove or shut off all sources of AC and DC power to the **SPS** inverter system. Turn off the AC line input circuit breaker at the service panel and place the **SPS Battery Switch S2** in the **OFF** position to make sure the unit will not supply output voltage.
- C) Whenever AC and/or DC voltage is applied, there will be AC voltage inside the **SPS** inverter system unit; the unit can supply power from AC line or from its batteries. To avoid equipment damage or personal injury, always assume that there may be voltage inside the **SPS** inverter system.
- D) Remove rings, watches, and other jewelry before installing the AC wiring. Always wear protective clothing and eye protection and use insulated tools when working near batteries. Whenever servicing an energized unit with the inside panel open, electric shock is possible; follow all local safety codes. **TEST BEFORE TOUCHING!**
- E) To reduce the risk of fire or electric shock, install the **SPS** inverter system and the batteries in a temperature-controlled and humidity-controlled indoor area free of conductive contaminants. See **Section 103** for operating environment specifications.

105.1 AC Wiring Preparations

1. Remove the system's front cover. Make sure the **SPS Battery Switch S2** is in the **OFF** position.
2. Make sure the **SPS** inverter system input and output voltages are correct for the particular application. Remember that the **SPS** system provides single-phase power only.
3. The input circuit breaker in the input service panel provides the means for disconnecting AC to the **SPS** inverter system. Only authorized persons shall be able to disconnect AC to the unit. (See **NEC 700-20 and 700-21**.)
CAUTION: To prevent electrical shock or equipment damage, for all units, the SPS Battery Switch S2 and the AC input circuit breaker at the service panel are all OFF before making AC connections to the SPS inverter system.
4. If not previously done, remove cabinet knockouts for AC Input and AC Output as described in **Sections 104-4, 104.5 or 104.6** depending on mounting method
CAUTION: Do not drill the cabinet; drill filings may damage the unit and prevent it from operating. If larger knockouts are needed, use a chassis punch to enlarge the appropriate knockout. Do not add additional or unnecessary knockouts.
5. Install the input and output conduits.
6. Run the AC Input service conductors and AC Output conductors through separate conduits. **SPS** inverter system emergency output circuits shall be installed in dedicated conduit systems and not shared with other electrical circuits as described in **NEC 700-9(b)**.

105.2 AC Input and AC Output Connections

CAUTION: Prior to making any wiring connections to unit make sure branch AC input circuit breaker feeding the SPS unit is turned off at the service panel!

The **SPS** models can be configured for various modes of operation and are described in this section. Refer to the appropriate wiring diagrams to properly connect the utility AC power, fixtures and external switching device (where applicable). Perform all wiring procedures in accordance with applicable codes.

Normally-On Operation - Fixtures remain illuminated in AC and emergency operating modes.

See "A" in **Wiring Diagram 1** for 120V wiring or "F" in **Wiring Diagram 2** for 277V wiring.

Normally-Off Operation - Fixtures illuminate only upon loss of utility AC power.

See "B" in **Wiring Diagram 1** for 120V wiring or "G" in **Wiring Diagram 2** for 277V wiring.

Normally-On and Normally-Off Operation - A combination of the operating modes described above.

See "C" in **Wiring Diagram 1** for 120V wiring or "H" in **Wiring Diagram 2** for 277V wiring.

Switched Load Operation - Single Circuit - Fixtures can be externally switched and will illuminate upon loss of utility AC power regardless of external switch position.

See "D" in **Wiring Diagram 1** for 120V wiring or "I" in **Wiring Diagram 2** for 277V wiring.

Switched Load Operation - Four Circuit (-4C Option) - Functionally identical to the Switched Load Operation above but provides for the operation of up to four individually switched output circuits.

See "E" in **Wiring Diagram 1** for 120V wiring or "J" in **Wiring Diagram 2** for 277V wiring.

Wiring Diagram 1 - 120VAC Connections

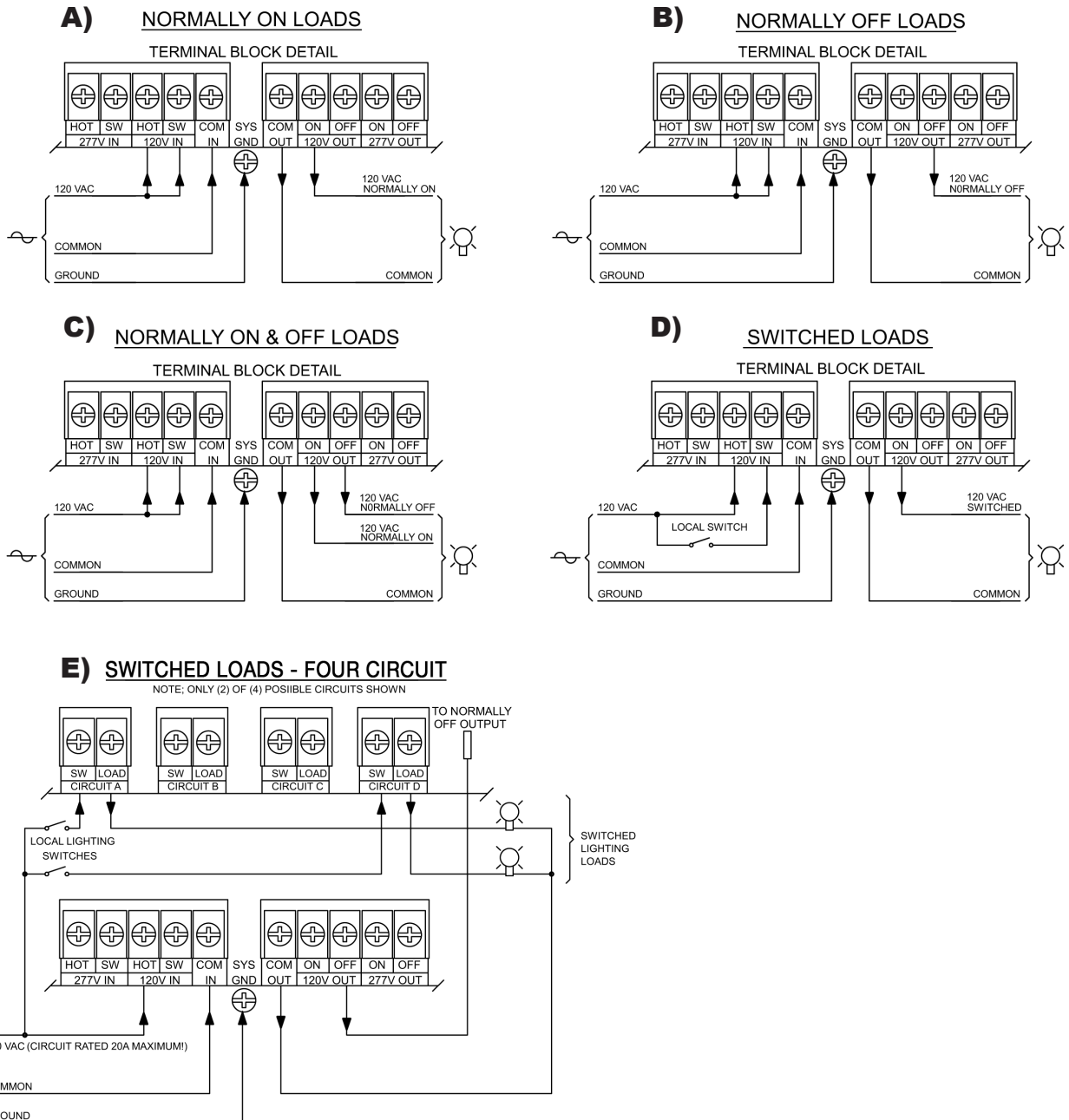

Wiring Diagram 2 - 277VAC Connections

F) NORMALLY ON LOADS

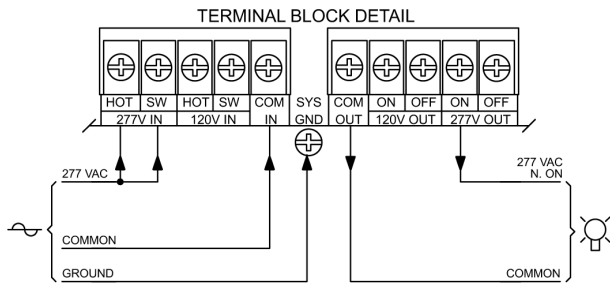

G) NORMALLY OFF LOADS

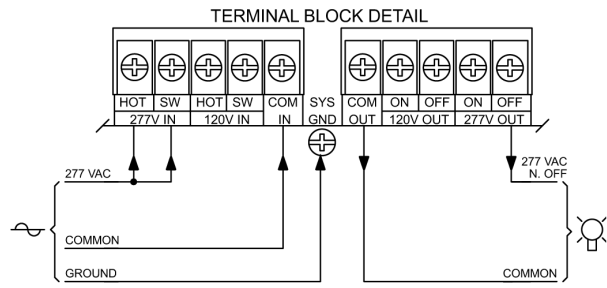

H) NORMALLY ON & OFF LOADS

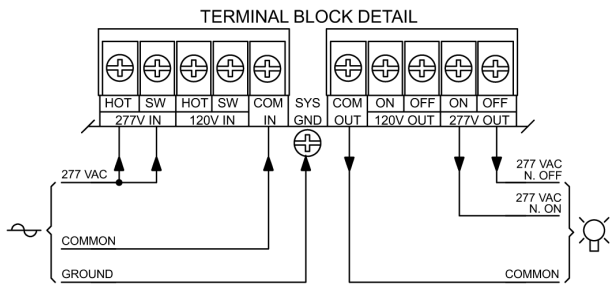

I) SWITCHED LOADS

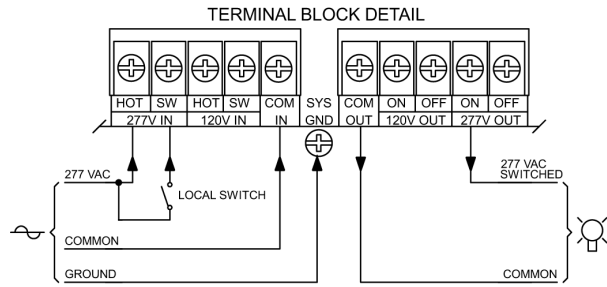

J) SWITCHED LOADS - FOUR CIRCUIT

NOTE: ONLY (2) OF (4) POSSIBLE CIRCUITS SHOWN

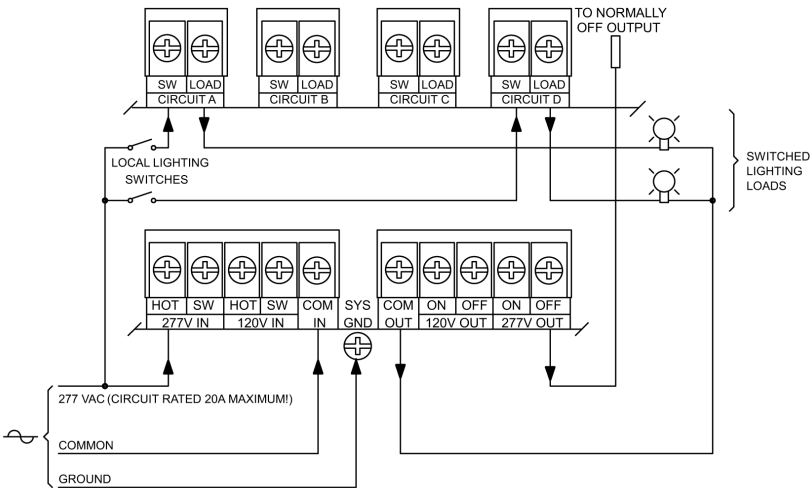

106. Battery Information

Important Safety Precautions

The installer must take these precautions:

- 1) *Wear protective clothing, eye-wear, rubber gloves and boots. Batteries contain corrosive acids or caustic alkalis and toxic materials and can rupture or leak if mistreated. Remove rings and metal wristwatches or other metal objects and jewelry. Don't carry metal objects in pockets where the objects can fall onto the batteries or into the **SPS** inverter system.*
- 2) *Tools must have insulated handles so that they will not short battery terminals. Do not allow a tool to short a battery terminal to another battery terminal or to the cabinet at any time. Do not lay tools or metal parts on top of the batteries, and do not lay any objects where they could fall onto the batteries or into the cabinet.*
- 3) *Install the batteries as shown on the battery wiring diagram provided in this manual. When connecting cables, never allow a cable to short across a battery's terminals, the string of batteries, or to the cabinet.*
- 4) *Keep the cable away from any sharp metal edges.*
- 5) *Install the battery cables so they cannot be pinched by the **SPS** inverter system cover/door.*
- 6) *Where conductors may be exposed to physical damage, protect conductors in accordance with **NEC** requirements.*
- 7) *Full voltage and current are always present at the battery terminals. The batteries used in this system can produce dangerous voltages, extremely high currents, and possible risk of electric shock. Batteries may cause severe injury if the terminals are shorted together or to ground (earth). Be extremely careful to avoid electric shock and burns caused by contacting battery terminals or shorting terminals during battery installation. Do not touch uninsulated battery terminals.*
- 8) *A qualified electrician who is familiar with battery systems and required precautions must install and service the batteries. Any battery used with this unit shall comply with the applicable requirements for batteries in the standard for emergency lighting and power equipment, UL 924. Cabinets are designed to be used with, and batteries must be replaced by identical cells or a Manufacturer approved equivalent. If using substitute batteries not supplied by the Manufacturer, the unit's UL listing will be void, and the equipment may fail to perform properly. The installation must conform to national and local codes as well. Keep unauthorized personnel away from batteries.*

106.1 Tools

The following tools are required to install the system batteries:

Socket Set, Tape, Digital Volt-Ohm Meter, Safety Glasses

CAUTION: Always use insulated tools for battery installation.

106.2 Battery Installation and Connection

CAUTION: Prior to connection of battery string to the inverter/charger assembly make sure the **SPS Battery Switch S2 is in the OFF (down) position.**

* **SPS-55/125 and SPS-110/125 Models** are supplied with two (2) batteries installed (24VDC string voltage) with the positive (+) battery lead disconnected. This connection will need to be completed prior to system startup. See **Wiring Diagrams 1 and 2** for verification of proper battery connections.

* **SPS-110/250 and SPS-220/250 Models** are supplied with four (4) batteries shipped separately (48VDC string voltage). See **Wiring Diagram 3** for battery connections. Install batteries with terminals facing outwards. Connect batteries using wiring conductors supplied with the system.

System Model Number	System DC Voltage	Number of Batteries	Battery Part Number	Wiring Diagram
SPS-55/125-S	24	2	03-002	1
SPS-110/125-S	24	2	03-001	1
SPS-110/250-S	48	4	03-002	3
SPS-110/250-S	48	4	03-001	3
SPS-55/125-R	24	2	03-002	1
SPS-110/125-R	24	2	03-001	1
SPS-55/125-T	24	2	03-002	2
SPS-110/125-T	24	2	03-001	2

IMPORTANT: Observe correct polarity on the battery terminals. Polarity markings may vary from battery to battery.

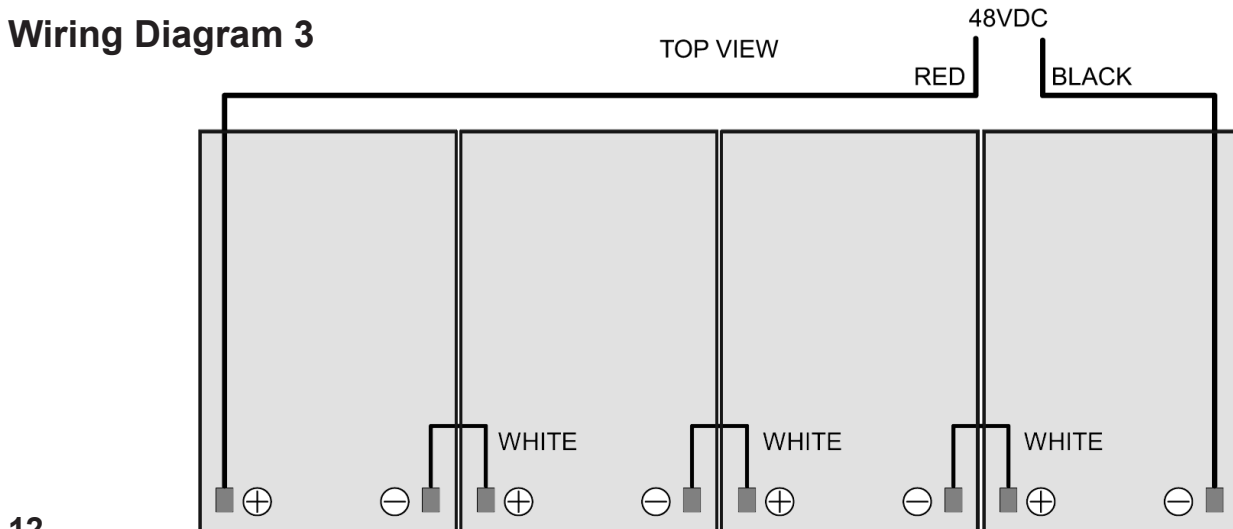
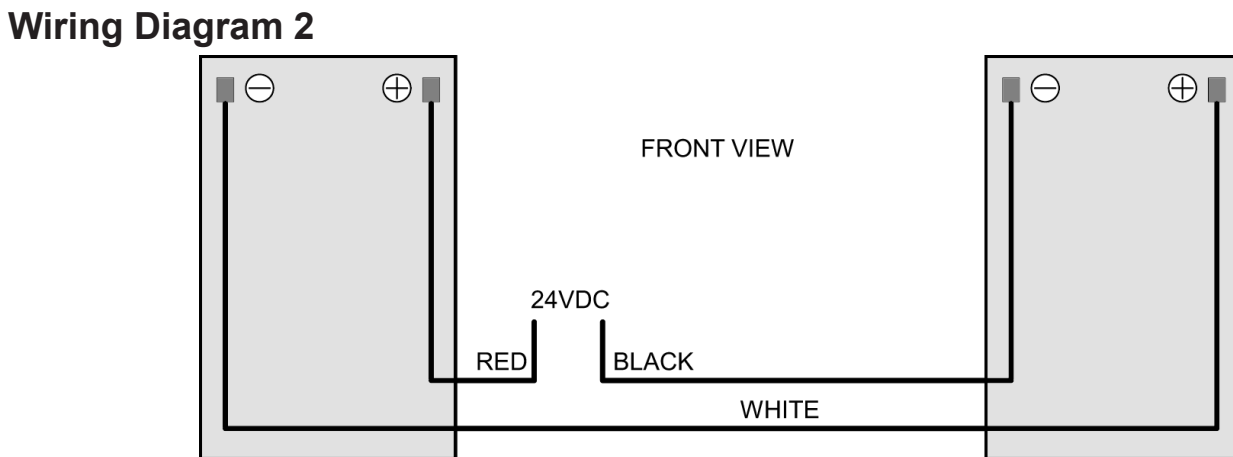
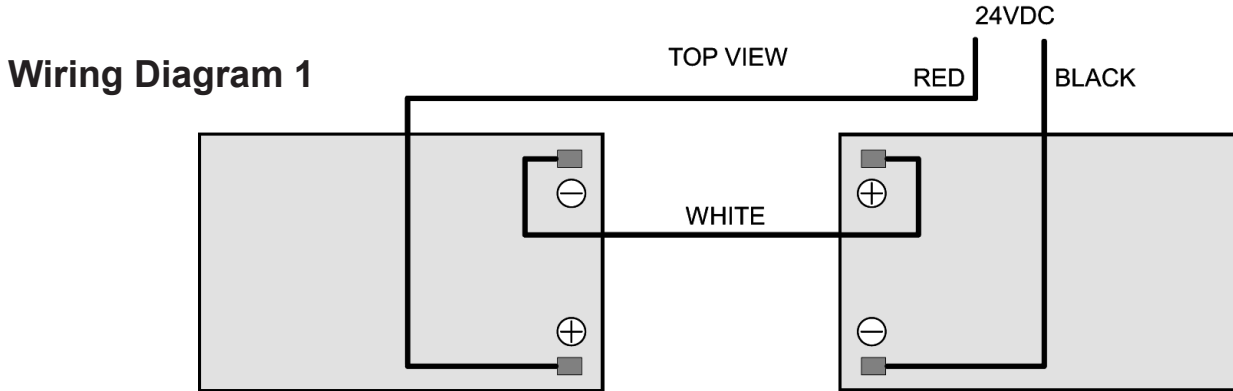

106.3 Battery Connection Voltage Check

Using a digital volt-ohm meter, check for correct nominal battery voltage between DC Input NEG and POS wires. Refer to table in **Section 106.2** for proper system DC voltage. Voltage reading should be $\pm 10\%$ of system DC voltage.

107. Final Installation Checklist

IMPORTANT: Before proceeding to the System Start-Up Procedure (Section 108) complete the Final Installation Checklist below.

1. Insure the SPS cabinet(s) is securely fastened to a wall or other structure.
2. Insure that the input circuit breaker in the building service panel serving as the AC disconnect to the SPS system is in the **OFF** position.
3. Check for proper ground connections in the **SPS** unit cabinet.
4. Check for any loose wiring connections in the **SPS** unit cabinet.
5. Check that correct nominal battery voltage (24 or 48 VDC) is present in the **SPS** unit between the DC Input **NEG** and **POS**. Refer to **Section 106.2** for proper system DC voltage.
6. Verify AC Input voltage to unit matches system voltage configuration.

108. System Start-Up Procedure

IMPORTANT: The SPS inverter system is a sophisticated electronic backup power supply. Care must be taken to follow the steps below in their exact sequence. Failure to do so may result in possible equipment failure.

CAUTION: Familiarize yourself with the shut down procedure in Section 200.1 before proceeding with the Start Up.

1. Hold **S1 PRECHARGE SWITCH** in the **ON** (up) position for **10 seconds**, then release.
2. Place **S2 BATTERY SWITCH** in the **ON** (up) position.
3. Apply utility AC power to the system using branch circuit breaker.
4. Observe the LED Status indicators and verify the following:
 - A) AC ON** indicator (red LED) is illuminated (indicates AC utility power is available to unit).
 - B) CHG ON** indicator (green LED) is illuminated (indicates battery is connected and charger is operational).
5. Verify **Normally-On** fixtures or switched fixtures (where applicable) are illuminated (local fixture switch must be in **ON** position).

109. System Test

Momentarily push **TEST** switch and verify the following:

- A) INV ON status indicator (yellow) illuminates (indicates inverter is operational).**
- B) Normally-On, Normally-Off and Switched fixtures are illuminated (where applicable).**

200. Maintenance

200.1 Safe Shut Down Procedure

CAUTION: To avoid possible equipment damage or personal injury, assume that there is AC voltage present inside the SPS inverter system unit any time AC input power or DC battery voltage is applied. The inverter is capable of providing output voltage from the batteries even when there is no AC input line voltage. When AC input voltage is present, the unit can provide output voltage even when the batteries are disconnected.

Do not touch components inside the unit. DC voltage is always present at the batteries and battery cables.

Final Shut Down Procedure

1. Open the unit's front access panel.
2. Place the **SPS Battery Switch S2** in the off **OFF** position and then place the **AC Input circuit breaker** at the service panel in the **OFF** position.
CAUTION: HAZARDOUS ENERGY IS STORED IN CAPACITORS INSIDE THE SPS UNIT. AFTER TURNING OFF SWITCHES, ALLOW 5 MINUTES FOR CAPACITORS TO DISCHARGE BEFORE ATTEMPTING ANY SERVICE PROCEDURES.
3. If the service technician does not need to access the inside of the unit, keep the unit's front cover/door closed.
4. If the unit will be shut off for an extended period of time, recharge batteries every 60 to 90 days.
CAUTION: The batteries will be damaged and the warranty voided if not routinely re-charged.

NOTE: To turn power back on, follow the "System Start-up Procedure" outlined in Section 108. Be sure to complete all of the steps to assure the unit will operate properly.

200.2 Routine System Maintenance

The **SPS** inverter system unit is designed to provide years of trouble-free operation. The unit does require some routine attention to assure peak performance. The Manufacturer recommends a Preventative Maintenance check be performed by a qualified service technician at least every six months. The technician must observe important safety precautions while performing the following recommended tasks:

- **Inspect and clean the unit interiors;**
- **Inspect all batteries for leaks, case swelling or terminal corrosion;;**
- **Perform an emergency operation test to check operation of all critical connected loads**

200.3 Manual Routine Inverter Tests

NFPA101 requires that Emergency Lighting Equipment be tested on a monthly basis for a period of at least 5 seconds, and a minimum of 90 minutes once a year. We strongly recommend these guidelines be followed to insure system readiness, and to prolong battery life. The **SPS** system was designed with a front panel test switch to facilitate monthly testing. Simply depress the button and hold to test the inverter at anytime. Once released, the **SPS** will revert back to standby operation. For annual 90-minute discharge or other prolonged tests, simply turn off the AC Input breaker at the service panel.

200.4 Routine Battery Inspection and Maintenance

Sealed Lead-Calcium Batteries

Lead-Calcium cells are the most common type of battery used today in standby equipment. By design it is as maintenance free as a battery can be. It is recommended, however, that some simple steps be taken to increase system life and maximize reliability:

- A) *A quarterly visual check of the batteries should be conducted to look for deformities in the cases and terminal corrosion. Any defective batteries should be replaced. All corroded terminals, regardless how slight, are to be cleaned and retightened at once to prevent failure of the entire battery bank.*
- B) *Once a year, all battery connections should be checked for tightness and re-tightened if necessary.*

200.5 Battery Replacement Procedure

WARNING:

Always use the same quantity and type of battery as replacements.

Substituting batteries not supplied by the Manufacturer will void the UL listing of the system and may cause equipment failure. To ensure the superior performance of your **SPS** inverter system and to maintain proper charger operation, replace spent batteries only with cells having the same part number, voltage and ampere-hour rating as the original batteries.

1. Follow the proper shut down procedure as described in **Section 200.1**.
2. Disconnect the battery string beginning with the white inter-cell connectors followed by the red (B+) and black (B-) connectors.
3. Remove the batteries from the cabinet.
4. Install new batteries following the instructions outlined in **Section 106.2**.

200.6 Battery Disposal

WARNINGS:

- *Do not dispose of batteries in a fire, the batteries could explode.*
- *Do not open or mutilate batteries.*
- *Released electrolyte is highly toxic and harmful to the skin and eyes.*

CAUTION: *Batteries contain lead. Many state and local governments have regulations about used battery disposal. Please dispose of the batteries properly.*

